



HECKLER & KOCH

NO COMPROMISE

G36 SERIES

GAS AIRSOFT / cal. 6 mm

powered by **UMAREX** www.umarex.com

UMAREX HOLDS THE WORLDWIDE EXCLUSIVE
HK-TRADEMARK AND EXTERIOR DESIGN COPY
LICENSE FOR USE WITH THIS PRODUCT,
GRANTED BY HECKLER & KOCH GMBH.



2.6382 | 2.6382X G36 C



2.6386 | 2.6386X G36 KV



2.6387 | 2.6387X G36 K

EN Operating instructions 2 - 8

DE Bedienungsanleitung 9 - 15

FR Mode d'emploi 16 - 22

ES Manual de instrucciones 23 - 29



SAFE GUN HANDLING

EN



DESCRIPTION



OPERATION



MAINTENANCE



SAFETY INSTRUCTIONS

You should be fully familiar with the proper and safe handling of your weapon. The basic principles of weapons safety require you to always apply the following rules when handling the firearm.

- Always treat a weapon as if it was loaded.
- Always put the safety of a weapon to "safe" when loading it so that there can be no unintentional discharge.
- Keep your finger away from the trigger. It should be straight and should rest on the trigger guard.
- Only use the kind of projectiles suitable for your weapon.
- Always keep the muzzle pointed in a safe direction.
- This weapon may only be discharged in your own house, on authorized shooting ranges and inside enclosed private property. It is to be made sure that no projectile can leave the enclosed property.
- Keep the danger area of the projectile in mind.
- Never transport a loaded weapon. Only load your weapon when you intend to fire it.
- Never aim your airgun at persons or animals. Avoid ricochets. Never fire at smooth, hard surfaces or water.
- Before you discharge your weapon, make sure that target and surrounding area are safe.
- Make sure that you always have full control over the muzzle of your weapon, even if you stumble or fall down.
- Safety shooting glasses should always be worn when firing the weapon.
- Always store your weapon in a safe place and in unloaded condition. Unauthorized persons (persons not familiar with the use of weapons, children) must not have access to it. Ammunition is to be kept in a separate place.
- This weapon and its instruction manual may only be passed on to persons
 - who are fully familiar with its use and
 - who have reached the legally stipulated minimum age in the respective country.
- Modifications or repairs of weapons are only to be effected by authorized agencies or by a skilled gunsmith.
- Never leave a loaded weapon unattended.
- Only unloaded weapons are to be handed over to another person.

REPAIR

A gun that does not work properly is dangerous. Repairing a gun by oneself is difficult and an incorrectly assembled gun can malfunction in dangerous ways.

Caution: Repairs should only be completed by Umarex authorized centres.



SAFETY INSTRUCTIONS | WARRANTY



CAUTION

For your own safety and the safety of others, carefully read these instructions before using this weapon. Buyers and owners must observe all rules concerning the use and ownership of air guns. Modifying this weapon may result in a change of its classification under weapons law and is therefore prohibited. In such cases the manufacturer's warranty will immediately become void.



WARNING

Do not brandish or display this airgun in public - it may confuse people and may be a crime. Police and others may think this airgun is a firearm. Do not change the coloration and markings to make it look more like a firearm. That is dangerous and may be a crime.

WARRANTY

During the legal warranty period, which begins on the date of purchase, Umarex will repair or replace your weapon at no charge provided the defect was not caused by you. Return your weapon to an authorized dealer along with a description of the problem and proof of purchase.

The air guns manufactured by Umarex GmbH & Co. KG are made according to the regulations of the PTB (Physikalisch-Technische Bundesanstalt), German federal law, the CIP regulations and the technical know-how of Umarex GmbH & Co. KG.

We will not assume any liability whatsoever if this product is exported to territories outside of Germany and as a consequence does not comply with domestic legal requirements of these territories. It will be the sole responsibility of the importer to ensure compliance with local laws and regulations.

TECHNICAL DATA

Item no.	2.6382	2.6382X	2.6386	2.6386X	2.6387	2.6387X
	G36 C		G36 KV		G36 K	
System	Gas Airsoft					
Caliber/Ammo	cal. 6 mm BB					
Energy	max. 1,3 JOULES	max. 1 JOULE	max. 1,6 JOULES	max. 1 JOULE	max. 1,6 JOULES	max. 1 JOULE
Velocity	up to 114 m/s with 0,20 g BB	up to 100 m/s with 0,20 g BB	up to 125 m/s with 0,20 g BB	up to 100 m/s with 0,20 g BB	up to 125 m/s with 0,20 g BB	up to 100 m/s with 0,20 g BB
Drive	Semi-Auto	Full-Auto	Semi-Auto	Full-Auto	Semi-Auto	Full-Auto
Rate of fire	-	800 rate/min	-	800 rate/min	-	800 rate/min
Colour	Black					
Barrel length	230 mm		390mm			
Weight	2520 g		2810 g		2875 g	
max. Length	720 mm		865 mm		865 mm	
Magazine capacity	30 BBs					
Danger Distance	200 m					



DESCRIPTION

EN

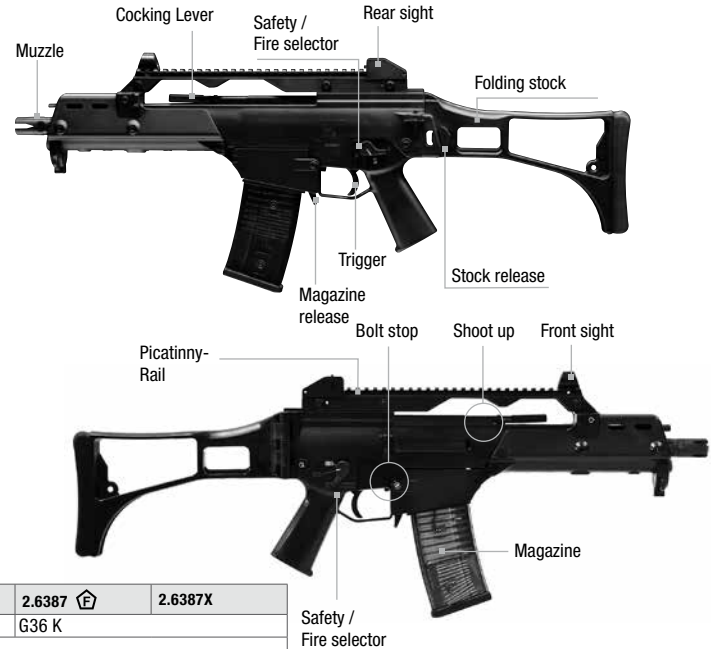



⚠ CAUTION

- Only handle your gun in its safe condition.
- Always make sure that the muzzle points in a safe direction.

⚠ CAUTION

Please also always observe the legal regulations effective in your country for the use of arms.

S-E-F Trigger group

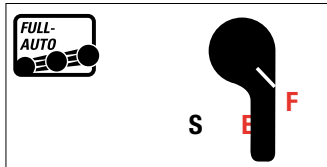
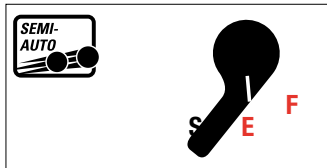
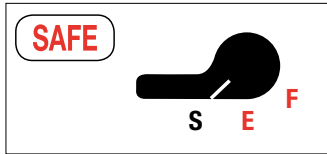

Pictogram Trigger group

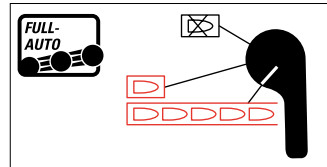
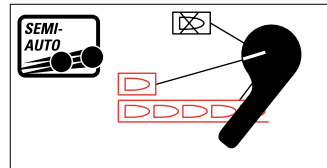
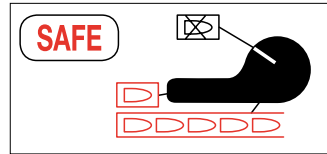

S-E-F Trigger group

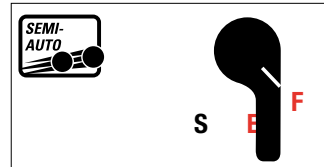
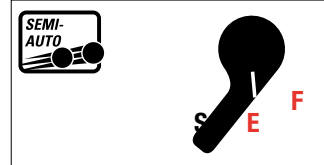

Pictogram Trigger group

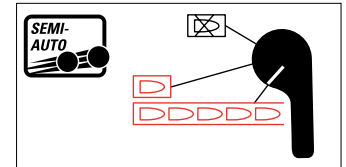
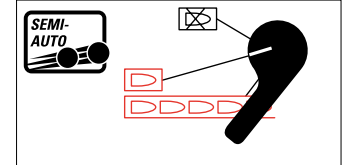

PROBLEM SOLUTIONS



PROBLEMS

- Faulty shooting direction
- Weapon does not shoot
- Low shooting speed

POSSIBLE CAUSES

	Safety activated	Gas / Magazine empty	Dirty barrel	Extreme temperatures	Wrong ammunition	Ammunition badly loaded	Weapon not cocked	Sight not properly adjusted
Faulty shooting direction			●	●	●	●		●
Weapon does not shoot	●	●					●	
Low shooting speed			●	●	●	●		



LOADING THE MAGAZINE

EN

NOTE

If you load BBs while shooting, you do not have to cock the rifle again.

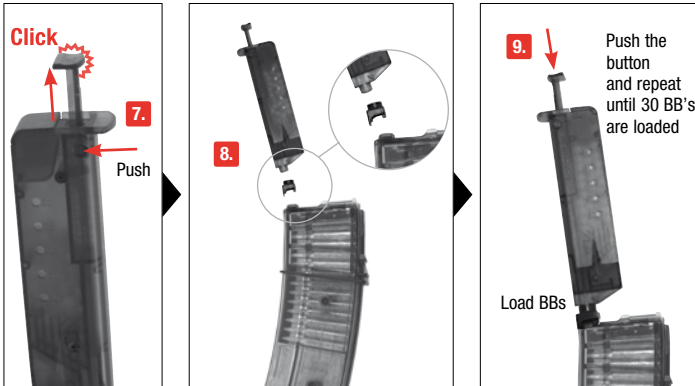
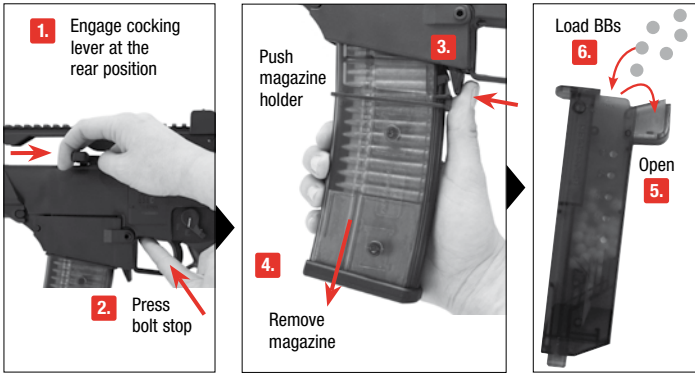

CAUTION

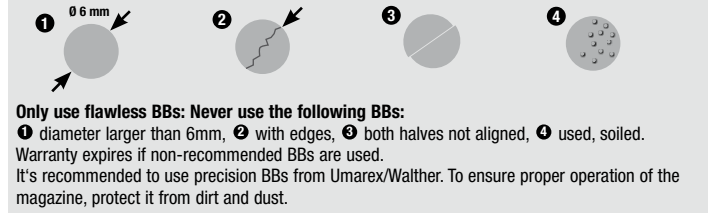



CHARGING OF GAS

⚠ CAUTION

- Keep hands and face at a safe distance from the escaping gas.
- Escaping gas may cause icing.
- Gas may explode if exposed to temperatures exceeding 50°C.
- Do not smoke, keep away from naked flames. The gas is highly inflammable.

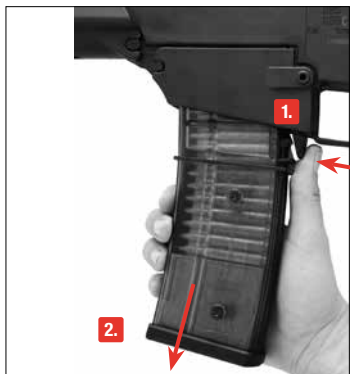

Press the magazine holder.
Pull out the magazine.

NOTE

Keep the magazine with gas tank tilted. Attach the gas flask vertically to the charging port of the magazine. Press the flask against the port. The magazine is fully charged when you observe a discharge of gas from the port.

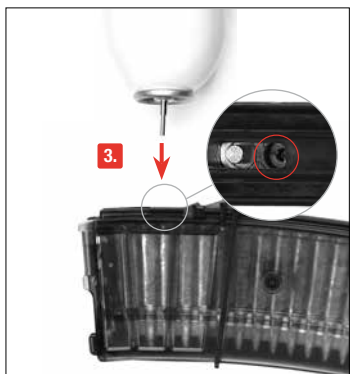

REMOVING OF GAS
Hold the magazine at its bottom. Press the valve. Residual gas may now be discharged.



ADJUSTABLE SHOOT UP

EN

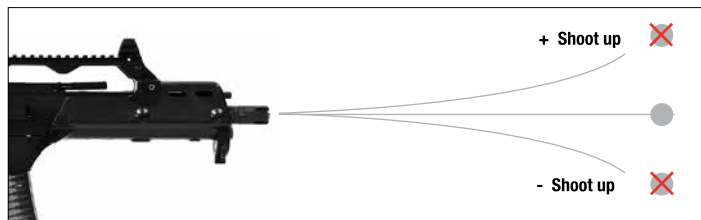



ADJUST THE DISTANCE / REARSIGHT



SCOPE

EN

Windage adjustment

Turn



Shoot too far right:



Shoot too far left:

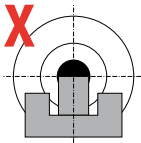
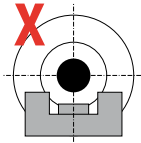
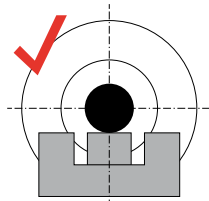

Scope magnification 3,5x

Elevation adjustment 2.6387/2.6387X G36K

Shoot too far high:



Shoot too far low:

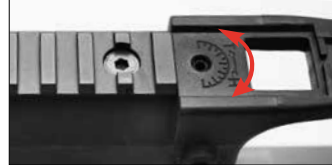

Windage adjustment 2.6387/2.6387X G36K

Shoot too far right:



Shoot too far left:

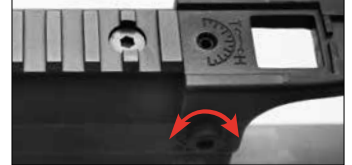

Elevation adjustment

2 mm Allen Key



Shoot too high:



Shoot too low:



Far distance



Short distance





STOCK / FIRING

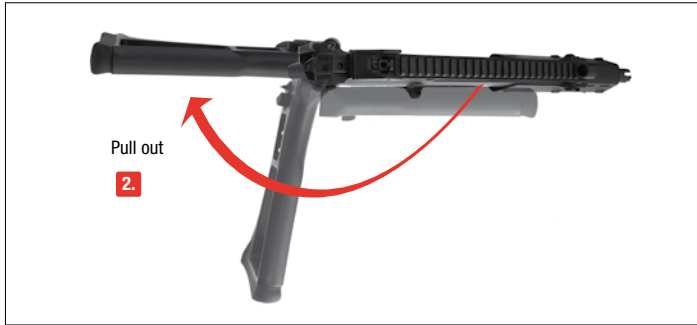
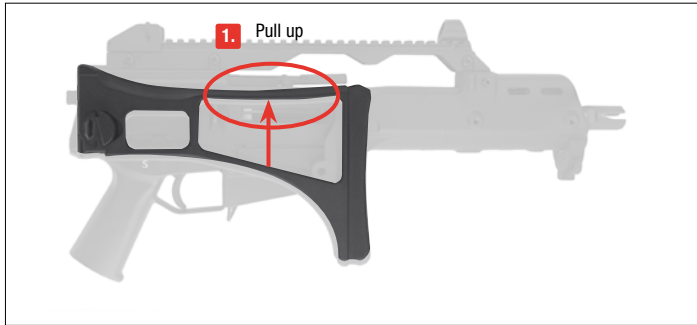

BARREL CLEANING

EN

⚠ CAUTION

Please do not switch the fire selector while pulling the trigger. This causes severe damage to your weapon.



⚠ CAUTION

- Do not force the rod into the barrel, as this could cause damage.
- Occasionally clean the metal parts on the outside. Use a cloth which has been slightly dampened with some weapon oil.
- Never drip silicone oil directly into the barrel.

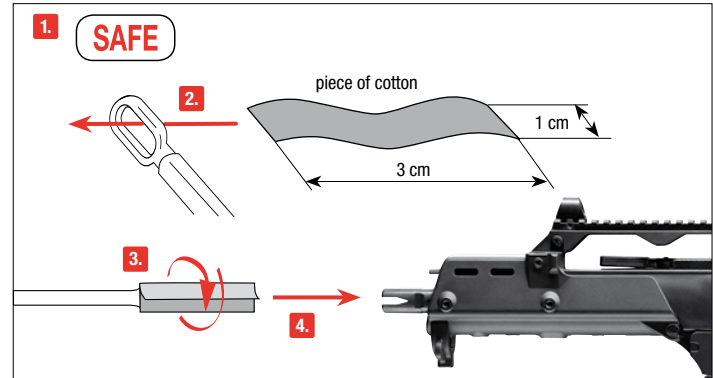

Put the safety on "safe". Prepare a thin rod with a length of approx. 50 cm. Attach a piece of cotton fabric to its end and clean the barrel with some silicone oil.



BENENNUNG



BEDIENUNG



PFLEGE





SICHERHEITSHINWEISE



ACHTUNG

Der Kauf und der Besitz der vollautomatischen Ausführung Art. Nr. 2.6382X, 2.6386X und 2.6387X ist laut Waffengesetz in Deutschland verboten!

Sie sollten mit der richtigen, sicheren Handhabung Ihrer Waffe vertraut sein. Im Hinblick auf die Grundregeln zum sicheren Schießen bedenken Sie, dass jede Berührung mit der Waffe als Handhabung verstanden wird.

- Behandeln Sie jede Waffe so, als wäre sie geladen.
- Die Waffe beim Laden stets sichern, so dass sich kein Schuss ungewollt lösen kann. Finger immer außerhalb des Abzugsbügels halten und nur zum Schuss an den Abzug legen.
- Verwenden Sie nur für diese Waffe vorgesehene Geschosse.
- Halten Sie die Mündung stets in eine sichere Richtung.
- Das Schießen ist nur in der eigenen Wohnung, auf polizeilich zugelassenen Schießständen und im befriedeten Besitztum erlaubt, wenn das Geschoss dieses beim Schuss nicht verlassen kann. Hierbei den Gefahrenbereich des Geschosses beachten.
- Transportieren Sie niemals eine geladene Waffe. Laden Sie nur, wenn Sie schießen möchten.
- Waffe niemals auf Menschen oder Tiere richten. Vermeiden Sie Querschläger. Schießen Sie niemals auf glatte, harte Oberflächen oder auf Wasserflächen.
- Vergewissern Sie sich vor dem Schuss, dass Ziel und Umgebungsbereich sicher sind.
- Kontrollieren Sie immer, ob die Waffe ungeladen ist, wenn Sie sie transportieren oder von einer anderen Person übernehmen.
- Vergewissern Sie sich, dass Sie, auch beim Stolpern oder Stürzen die Richtung der Mündung kontrollieren können.
- Aus Sicherheitsgründen sollte beim Schießen eine Schutzbrille getragen werden.
- Aufbewahren der Waffe stets sicher und ungeladen vor unerlaubtem Zugriff Unbefugter (ungeschulte Personen, Kinder, Personen unter 18 Jahren) und getrennt von der Munition.
- Weitergabe dieser Waffe mit der Bedienungsanleitung nur an Personen - die mit der Handhabung dieser Waffe genauestens vertraut und bei Waffen mit -Zeichen mindestens 18 Jahre alt sind.
- Druckluftwaffen mit Energie > 0,5 Joule aber ohne -Zeichen sind erwerbscheinpflichtig.
- Jegliche Veränderungen oder Reparaturen von Waffen sollten nur von fachkundigen Firmen oder vom Büchsenmacher durchgeführt werden.
- Legen Sie niemals eine geladene Waffe aus der Hand.
- Geben Sie nur entladene Waffen an andere Personen weiter.

REPARATUR

Eine Waffe, die nicht einwandfrei funktioniert, ist gefährlich. Es ist schwierig, eine Waffe selbst zu reparieren, und falscher Zusammenbau kann zu gefährlichen Funktionsstörungen führen.

Achtung: Lassen Sie die Waffe nur von einem autorisiertem Fachhändler/ Büchsenmacher überprüfen und reparieren.



SICHERHEITSHINWEISE | GARANTIE



ACHTUNG

Zu Ihrer eigenen und zur Sicherheit anderer lesen Sie die Bedienungsanleitung vollständig und sorgfältig durch, bevor Sie mit der Waffe erstmalig hantieren. Käufer und Besitzer haben die Pflicht, alle Regeln über den Gebrauch und den Besitz von Druckluftwaffen zu befolgen. Jede Änderung an dieser Waffe kann zu einer Änderung der waffenrechtlichen Einstufung führen und ist somit unzulässig. Die Gewährleistung des Herstellers erlischt in diesem Fall sofort.



WARNUNG

Diese Druckluftwaffe nicht in der Öffentlichkeit zeigen oder mit ihr drohen – es führt zu Verwechslungen mit echten Waffen und gilt als Straftat. Ändern Sie keinesfalls die Farbe und Markierungen der Druckluftwaffe, um ihr Aussehen mehr einer realen Schusswaffe anzugleichen. Dies ist gefährlich und kann als Straftat gelten.

GARANTIE

Innerhalb des gesetzlich festgelegten Zeitraumes ab Kaufdatum repariert oder ersetzt Ihnen die Fa. Umarex Ihre Waffe kostenlos, falls der Defekt nicht durch Eigenverschulden aufgetreten ist. Geben Sie die Waffe einem autorisierten Händler, beschreiben Sie ihm das Problem und fügen Sie den entsprechenden Kaufbeleg bei.

Die von Umarex GmbH & Co. KG hergestellten Druckluftwaffen werden gemäß den Zulassungsvorschriften der Physikalisch-Technischer Bundesanstalt (PTB), dem Bundesgesetz, den CIP-Vorschriften und dem waffentechnischen Know-how der Firma Umarex GmbH & Co. KG hergestellt.

Somit übernehmen wir keine Haftung, falls diese Ware nach dem Export ins Ausland nicht den dort geltenden Rechtsvorschriften entsprechen sollte und dem Besitzer/Käufer juristische Schwierigkeiten und Konsequenzen daraus entstehen sollten.

TECHNISCHE DATEN

Art. Nr.	2.6382	2.6382X	2.6386	2.6386X	2.6387	2.6387X
	G36 C		G36 KV		G36 K	
System	Gas Airsoft					
Kaliber/Munition	cal. 6 mm BB					
Energie	max. 1,3 JOULES	max. 1 JOULE	max. 1,6 JOULES	max. 1 JOULE	max. 1,6 JOULES	max. 1 JOULE
Geschwindigkeit	bis 114 m/s mit 0,20 g BB	bis 100 m/s mit 0,20 g BB	bis 125 m/s mit 0,20 g BB	bis 100 m/s mit 0,20 g BB	bis 125 m/s mit 0,20 g BB	bis 100 m/s mit 0,20 g BB
Funktion	Semi-Auto	Full-Auto	Semi-Auto	Full-Auto	Semi-Auto	Full-Auto
Kadenz	-	800 Schuss/min	-	800 Schuss/min	-	800 Schuss/min
Farbe	Schwarz					
Lauflänge	230 mm		390mm			
Gewicht	2520 g		2810 g		2875 g	
max. Gesamtlänge	720 mm		865 mm		865 mm	
Magazinkapazität	30 BBs					
Gefahrenbereich max.	200 m					



BENENNUNG

DE





⚠️ ACHTUNG

Hantieren Sie nur mit der Waffe, wenn diese gesichert ist. Achten Sie stets darauf, dass die Mündung in eine sichere Richtung zeigt.

⚠️ ACHTUNG

DE

In Deutschland werden die Waffen aus gesetzlichen Gründen nur als SEMIAUTO vertrieben. Bitte beachten Sie das jeweilige Waffengesetz in Ihrem Land.

S-E-F Abzugsgruppe

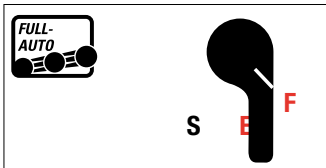
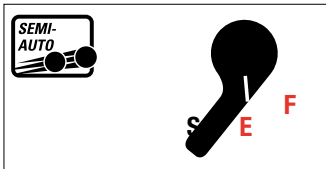
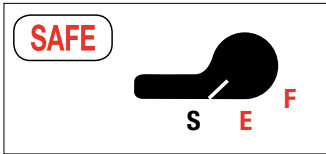

Piktogramm Abzugsgruppe

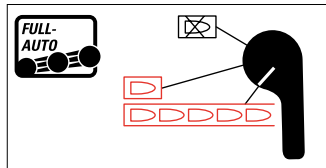
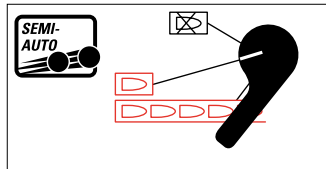
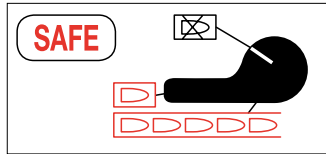

S-E-F Abzugsgruppe

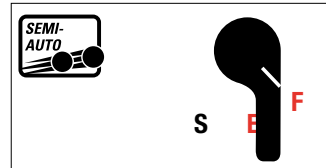
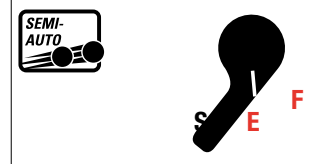

Piktogramm Abzugsgruppe

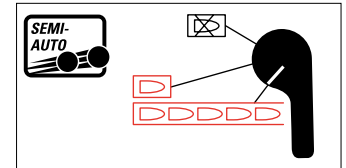
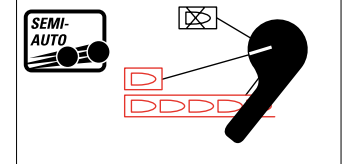

PROBLEMLÖSUNGEN



PROBLEME

schlechte Schussleistung
 Waffe schießt nicht
 geringe Geschwindigkeit

MÖGLICHE GRÜNDE

	Waffe gesichert	Akku / Magazin leer	Lauf verschmutzt	Extreme Temperaturen	Falsche Munition	Munition falsch geladen	Visierung nicht richtig eingestellt
schlechte Schussleistung			●	●	●	●	●
Waffe schießt nicht	●	●			●	●	
geringe Geschwindigkeit			●	●	●	●	



GAS EINFÜLLEN

⚠️ ACHTUNG

- Gesicht und Hände in sicherem Abstand von dem entströmendem Gas halten.
- Entströmendes Gas kann Vereisungen verursachen.
- Gas keiner großen Hitze aussetzen, es kann ab 50°C explodieren.
- Nicht rauchen, kein offenes Feuer. Das Gas ist hochentzündlich.



HINWEIS

Halten Sie das Magazin mit Gastank nach unten geneigt. Stecken Sie die Gasflasche senkrecht in die Einfüllöffnung des Magazins. Drücken Sie die Gasflasche in die Einfüllöffnung. Wenn Gas aus der Einfüllöffnung entweicht, ist das Magazin mit Gas gefüllt.

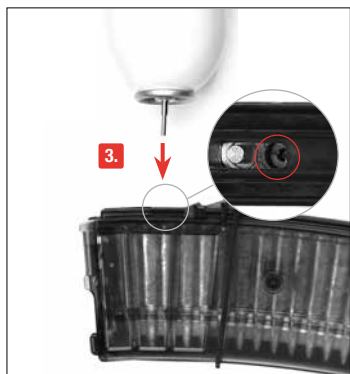

MAGAZIN LADEN

DE

⚠️ ACHTUNG

Wenn Sie während des Schießens BBs nachladen, ist ein erneutes Spannen nicht erforderlich.

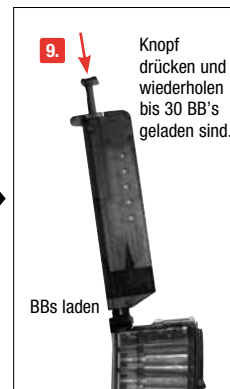
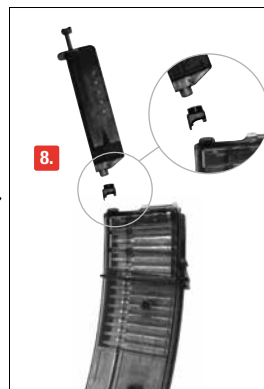
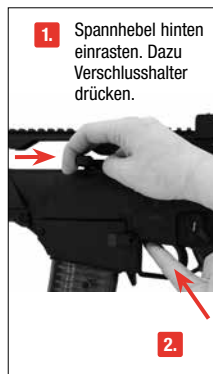



SHOOT UP EINSTELLEN

DE

⚠️ ACHTUNG



Verwenden Sie nur einwandfreie BB-Kugeln: $\varnothing 6 \text{ mm}$.

Verwenden Sie auf keinen Fall folgende BB-Kugeln:

1 Durchmesser größer als 6 mm, 2 mit Grat, 3 versetzte Hälften, 4 gebraucht, verschmutzt. Bei Gebrauch ungeeigneter Geschosse erlischt die Garantie. Empfohlen werden Präzisionsrundkugeln des Herstellers Umarex/Walther. Vermeiden Sie das Eindringen von Schmutz und Staub in das Magazin.

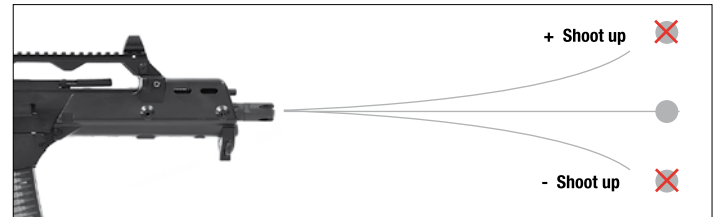
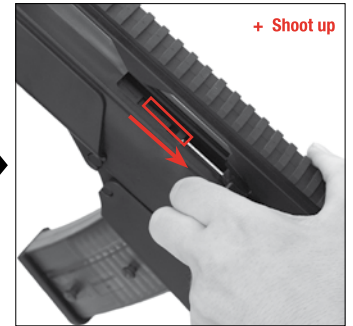
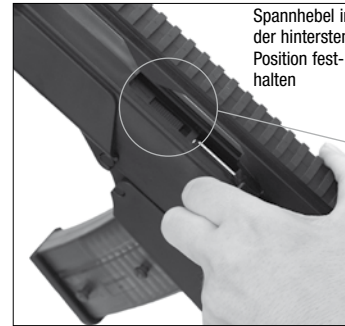



VISIERUNG EINSTELLEN

Seitenverstellung

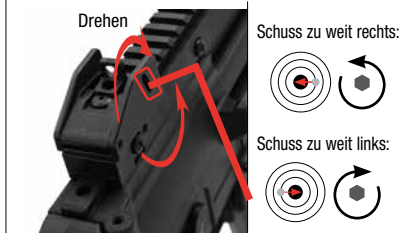

Höhenverstellung

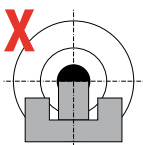
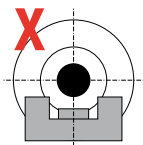
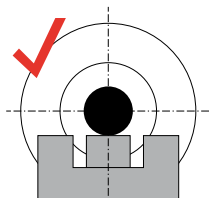
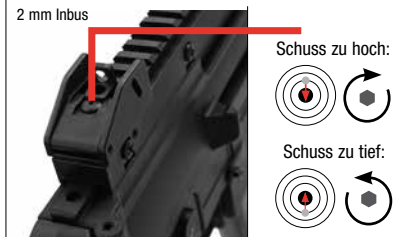

ZIELFERNROHR

DE

Zielfernrohr 3,5x Vergrößerung

Höhenverstellung 2.6387 / 2.6387X G36K

Schuss zu hoch:



Schuss zu tief:



Seitenverstellung 2.6387 / 2.6387X G36K

Schuss zu weit rechts:



Schuss zu weit links:

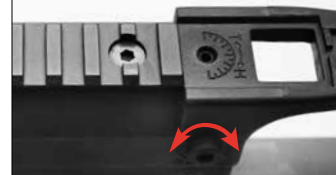

Große Entfernung



Kleine Entfernung





SCHAFT / SCHIESSEN

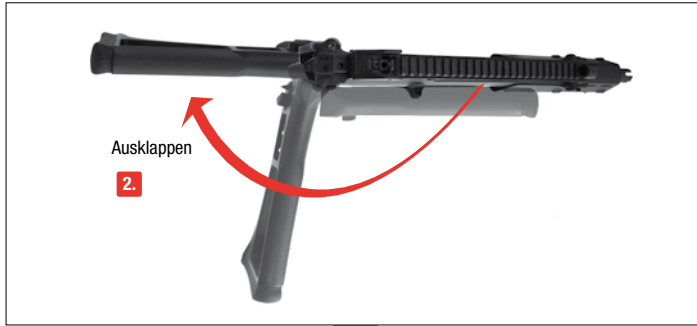
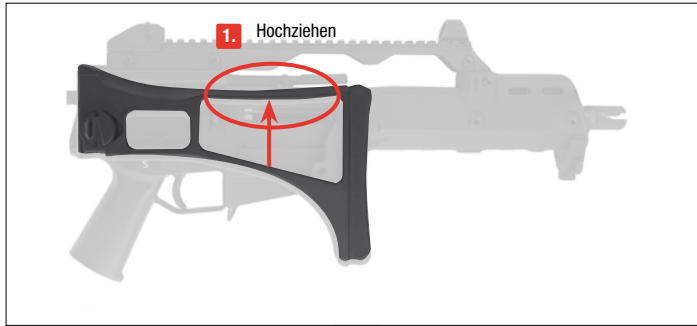

LAUFREINIGUNG

DE

⚠️ ACHTUNG

Schalten Sie niemals, während Sie den Abzug betätigen, den Feuerwahlhebel um. Dies verursacht schwere Schäden an Ihrer Waffe.



⚠️ ACHTUNG

- Schieben Sie den Stab niemals mit Gewalt in den Lauf, dies kann Beschädigungen verursachen.
- Reinigen Sie gelegentlich die äußeren Metallteile. Benutzen Sie dazu ein Tuch, auf das Sie leicht Waffenöl aufgetragen haben.
- Geben Sie niemals das Waffen-Öl direkt in den Lauf.

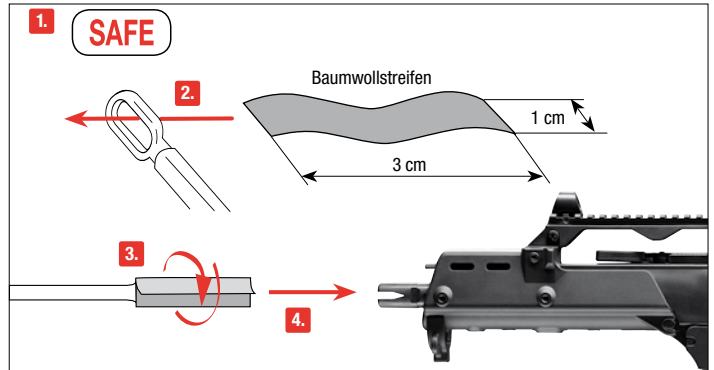

Sichern Sie die Waffe. Nehmen Sie einen ca. 50 cm dünnen, langen Stab. Wickeln Sie ein Stück Baumwolltuch um das Ende, benetzen Sie das Tuch mit etwas Waffen-Öl und reinigen Sie damit den Lauf.



DESIGNATION



UTILISATION



ENTRETIEN



INSTRUCTIONS DE SÉCURITÉ

Vous devez savoir manier votre arme correctement et de manière sûre et devez impérativement respecter les règles de base de tir en toute sécurité à chaque fois que vous manipulez l'arme.

- Maniez toujours l'arme comme si elle était chargée.
- Mettez toujours la sûreté avant de charger l'arme afin d'éviter tout tir involontaire.
- Ne mettez pas le doigt sur la détente et ne l'y placez que lorsque vous allez tirer.
- N'utilisez que les projectiles prévus pour cette arme.
- Pointez toujours la bouche de l'arme dans une direction non dangereuse.
- Il n'est permis de tirer avec l'arme que sur le lieu de résidence du propriétaire ou dans des zones de tir autorisées par la police, à condition que le projectile ne puisse pas sortir de la zone de tir. Veuillez toujours prendre en compte la zone de danger maximale du projectile.
- Ne transportez jamais l'arme lorsqu'elle est chargée. Ne la chargez que lorsque vous vous apprêtez à tirer.
- Ne dirigez jamais l'arme vers des personnes ni des animaux. Évitez les tirs pouvant faire ricocher le projectile. Ne tirez jamais sur des surfaces planes et dures, ni sur une surface d'eau car les projectiles peuvent ricocher.
- Avant de tirer, assurez-vous que l'objectif et les alentours ne présentent pas de danger.
- Vérifiez toujours que l'arme est déchargée avant de la transporter ou de la remettre à autrui.
- Veillez à maîtriser la direction dans laquelle la bouche de l'arme est pointée, même si vous trébuchez ou tombez.
- Pour des raisons de sécurité, portez des lunettes de protection lorsque vous tirez.
- Rangez toujours l'arme déchargée, séparée des munitions et dans un endroit sûr afin d'éviter que des personnes non autorisées (personnes non formées, enfants) puissent y avoir accès.
- Ne remettez cette arme, accompagnée du mode d'emploi, qu'à des personnes
 - qui sont le plus possible formées au maniement de cette arme et
 - qui ont atteint l'âge minimum légal selon la loi sur les armes en vigueur dans votre pays.
- Toute modification ou réparation de l'arme devra être effectuée par une entreprise spécialisée ou un armurier.
- Ne laissez jamais l'arme chargée sans surveillance.
- Déchargez toujours l'arme avant de la remettre à autrui.

RÉPARATIONS

Une arme qui ne fonctionne pas parfaitement est dangereuse. Il est difficile de réparer une arme soi-même, et un remontage incorrect peut entraîner des dysfonctionnements dangereux.

Attention : seules des personnes spécialisées agréées ou un armurier peuvent contrôler et réparer l'arme.

Cette boîte contient: une réplique d'arme factice avec chargeur. Les AIRSOFT GUNS sont des modèles d'armes factices tirant des billes en plastique de 6 mm inoffensives. Ce modèle a une énergie comprise entre 0,08 joule et inférieure ou égale à 2 joules. En France, la vente de ces produits est réglementée par le décret n°99-240 du 24 mars 1999, qui interdit la distribution des modèles noirs ou chromés dont l'énergie est comprise entre 0,08 et 2 joules aux moins de 18 ans non accompagnés. Ce décret ne concerne pas les modèles transparents, les game guns (oranges) et les mini guns, dont la distribution reste donc autorisée aux mineurs.

- Distribution et vente interdite aux mineurs. • Attention: Ne jamais diriger le tir vers une personne.



CONSIGNES DE SÉCURITÉ | GARANTIE



ATTENTION

Pour votre sécurité et celle d'autrui, lisez attentivement la notice d'emploi avant d'utiliser l'arme pour la première fois. Les vendeurs, tout comme les acheteurs, ont l'obligation de respecter le règlement relatif à l'utilisation et à la possession d'armes à air comprimé. Il est interdit de procéder à toute modification de ce pistolet car cela pourrait entraîner un changement dans la classification correspondant à la législation sur les armes à feu. De plus, toute modification entraînerait l'annulation immédiate de la garantie du fabricant.



MISE EN GARDE

Mise en garde: N'exhibez pas cette arme à air comprimé et ne la sortez pas en public. Cela pourrait prêter à confusion ou être considéré comme un délit. Les membres des forces de sécurité et la police pourraient la prendre pour une vraie arme à feu. Ne changez pas sa couleur ni les éléments d'identification pour qu'elle ressemble plus à une vraie arme à feu. Cela serait dangereux et peut être considéré comme un délit.

GARANTIE

La société Umarex s'engage à réparer ou à remplacer votre arme durant une période déterminée légalement à compter de la date d'achat, à condition que vous ne soyez pas responsable du défaut. Pour cela, remettez l'arme à un revendeur autorisé, décrivez-lui le problème et joignez le justificatif d'achat correspondant. Les armes à air comprimé de la société Umarex GmbH & Co. KG sont fabriquées conformément aux directives de conformité de l'institut allemand « Physikalisch-Technische Bundesanstalt (PTB) », à la loi fédérale, aux prescriptions CIP et au savoir-faire technique de la société Umarex GmbH & Co. KG dans le domaine des armes. Ainsi, nous ne pouvons être tenus responsables si, après exportation à l'étranger, cette marchandise ne répond pas aux prescriptions légales en vigueur dans le pays en question et si le possesseur/acheteur doit pour cette raison faire face à des difficultés juridiques ou toute autre conséquence pouvant découler de ce fait.

FICHE TECHNIQUE

Numéro d'article	2.6382	2.6382X	2.6386	2.6386X	2.6387	2.6387X
	G36 C		G36 KV		G36 K	
Système	Gas Airsoft					
Calibre / Munitions	cal. 6 mm BB					
Énergie	max. 1,3 JOULES	max. 1 JOULE	max. 1,6 JOULES	max. 1 JOULE	max. 1,6 JOULES	max. 1 JOULE
Vitesse	jusque 114 m/s avec 0,20 g BB	jusque 100 m/s avec 0,20 g BB	jusque 125 m/s avec 0,20 g BB	jusque 100 m/s avec 0,20 g BB	jusque 125 m/s avec 0,20 g BB	jusque 100 m/s avec 0,20 g BB
Action	Semi-Auto	Entièrement automatique	Semi-Auto	Entièrement automatique	Semi-Auto	Entièrement automatique
Cadence	-	800 tir/min	-	800 tir/min	-	800 tir/min
Couleur	Noir					
Longueur du canon	230 mm		390mm			
Poids	2520 g		2810 g		2875 g	
Longueur	720 mm		865 mm		865 mm	
Capacité du chargeur	30 BBs					
Distance dangereuse	200 m					

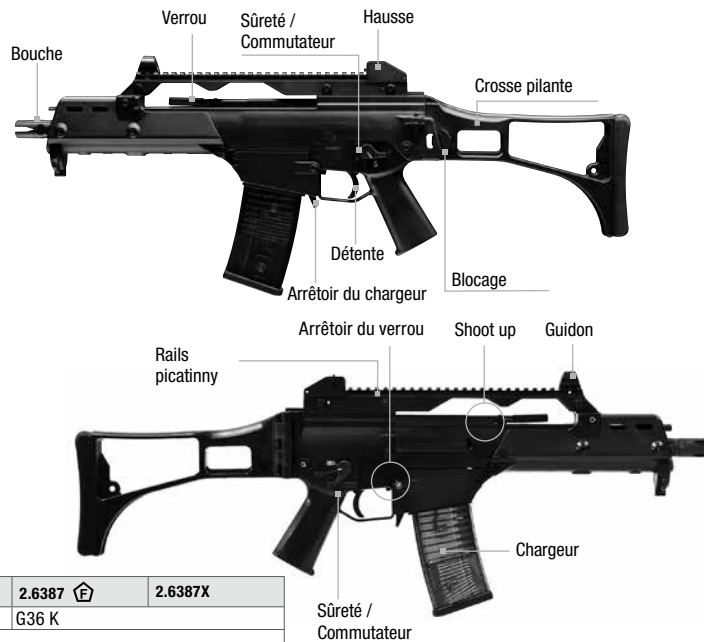

DÉSIGNATION DES PIÈCES

FR



⚠ ATTENTION

Assurez-vous que la bouche est orientée dans une direction non dangereuse.

S-E-F ensemble détente

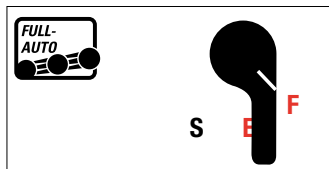
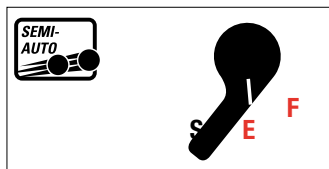
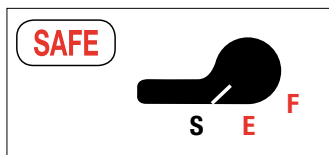

Pictogramme ensemble détente

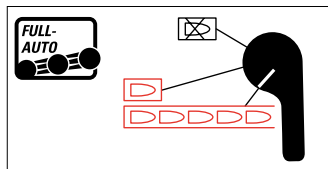
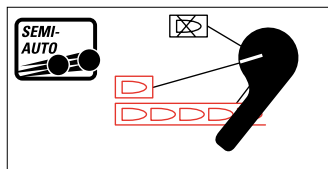
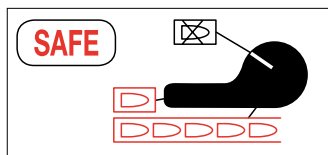

⚠ ATTENTION

Veillez à respecter la législation sur les armes en vigueur dans votre pays !

S-E-F ensemble détente

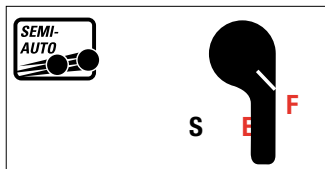
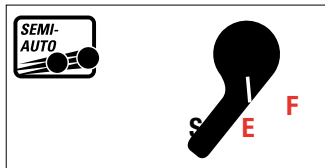

Pictogramme ensemble détente

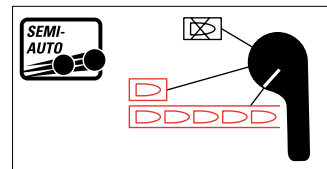
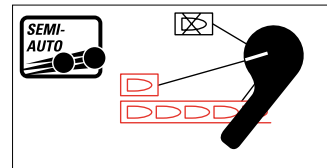

DYSFONCTIONNEMENTS



DYSFONCTIONNEMENTS

Mauvaise performance de tir

l'arme ne tire pas

Faible vitesse du projectile

CAUSES POSSIBLES

	sûreté de l'arme encadrée	L'accu / Chargeur vide	canon encrassé	températures extrêmes	mauvaises munitions	munitions mal chargées	dispositif de visée mal réglé
Mauvaise performance de tir			●	●	●	●	●
l'arme ne tire pas	●	●			●	●	
Faible vitesse du projectile			●	●	●	●	



REMARQUE

Si vous rechargez des billes BB pendant le tir, il n'est pas nécessaire de réarmer.

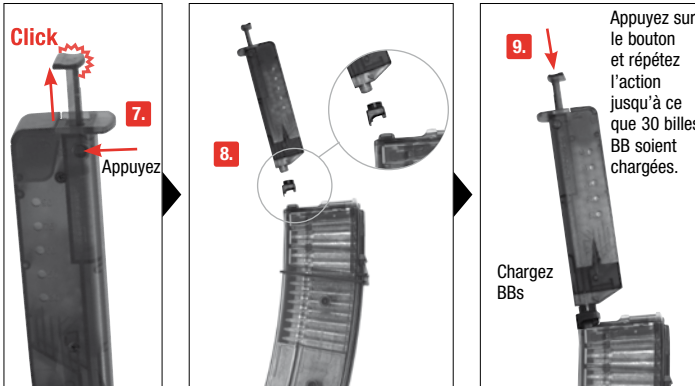
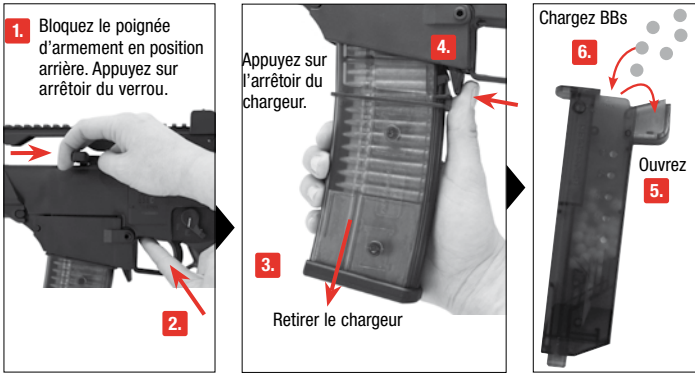

ATTENTION

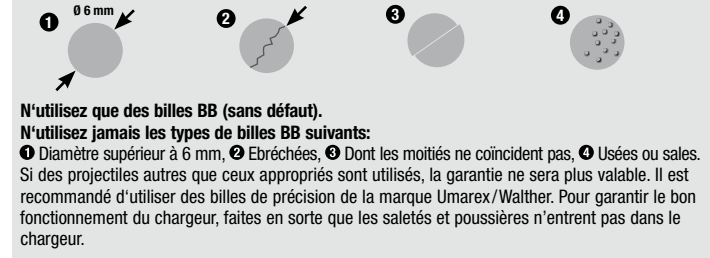

30 ROUNDS	6 mm AIRSOFT	WEIGHT 0,2 g BB	WEIGHT 0,25 g BB
---------------------	------------------------	----------------------------------	-----------------------------------





CHARGEMENT DU GAZ

⚠ ATTENTION

- Maintenez la bonbonne de gaz à une distance raisonnable de votre visage et de vos mains.
- Les éventuelles fuites de peuvent provoquer une engelure.
- Ne les exposez pas à une chaleur excessive et ne les conservez pas à des températures supérieures à 50 °C.
- Ne fumez pas et tenez-vous loin de toute flamme. Le gaz est hautement inflammable.



Appuyez sur l'arrêt du chargeur. Retirez le chargeur du pistolet par la partie inférieure de la poignée.

REMARQUE

Maintenez le chargeur pour gaz tank incliné vers le bas. Introduisez l'embouchure de la bonbonne de gaz dans l'ouverture du chargeur en position verticale. Enfoncez la bonbonne de gaz dans l'ouverture du chargeur. Lorsque le gaz s'échappe par les côtés de l'ouverture du chargeur, cela signifie que le chargeur est plein.

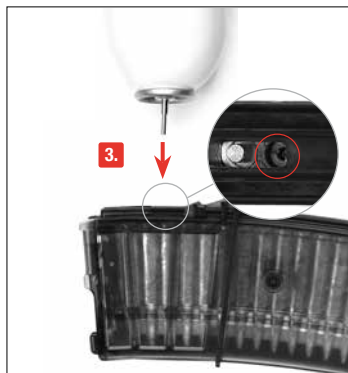

ÉLIMINER DU GAZ

Tenez le chargeur vers le bas. Appuyez sur la valve et déplacez la sûreté de celle-ci vers le haut. Le gaz restant sortira du chargeur.



AJUSTAGE SHOOT UP

FR

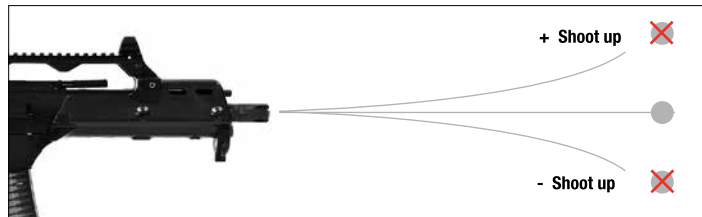



AJSUTAGE LA DISTANCE / HAUSSE



TÉLÉSCOPE

FR

Ajustage de latéral

Serrez



Tir trop à droite :



Tir trop à gauche :



Ajustage d'hauteur

Clé mâle à six pans 2 mm



Tir trop haut :



Tir trop bas :

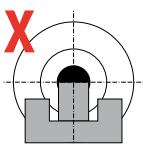
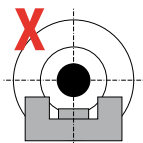
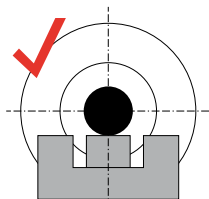

Télescope grossissement: 3,5-fois

Ajustage d'hauteur 2.6387 / 2.6387X G36K

Tir trop haut :



Tir trop bas :

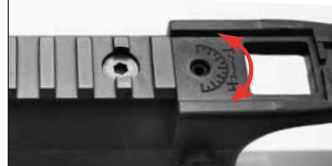

Ajustage latéral 2.6387 / 2.6387X G36K

tir trop à gauche :



tir trop à droite :

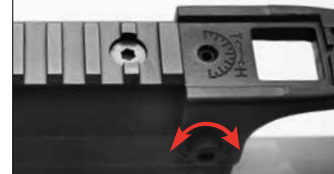

Grande distance



Petite distance



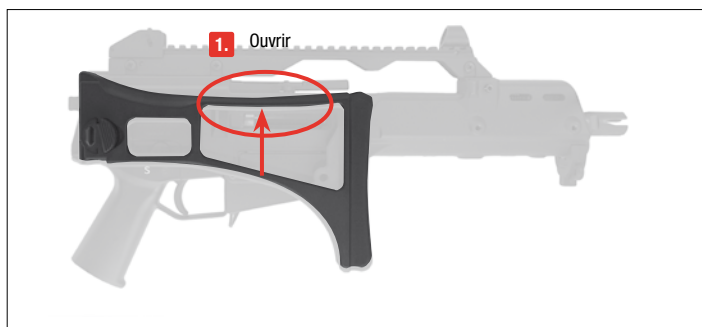

⚠ ATTENTION

N'actionnez jamais le commutateur pendant que vous appuyez sur la détente. Cela entraîne de graves dommages.



⚠ ATTENTION

- N'enfoncez pas la baguette de nettoyage violemment dans le canon, car elle pourrait l'endommager.
- Nettoyez les pièces métalliques extérieures à l'aide d'un chiffon doux préalablement imbibé d'huile pour armes.
- Ne versez jamais l'huile de silicone directement dans le canon.

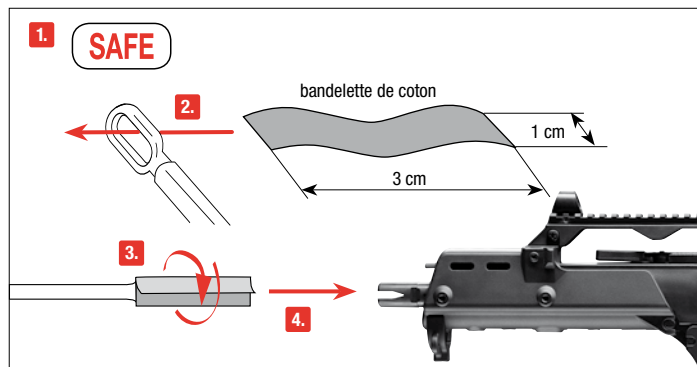

Mettez la sûreté de l'arme. Utilisez une tige fine d'une longueur d'env. 50 cm. Enroulez une bandelette de coton à son extrémité et nettoyez le canon avec une petite quantité d'huile de silicone.



DESIGNACION



REGLAJE



CUIDADOS



INSTRUCCIONES DE SEGURIDAD

Deberá estar familiarizado con el manejo correcto y seguro de su arma. Con respecto a las reglas básicas para disparar con seguridad, considere cada contacto con el arma como parte de su manejo.

- Trate el arma como si siempre estuviera cargada.
- Cargue siempre el arma con el seguro activado para evitar disparos involuntarios.
- Mantenga el dedo siempre fuera del gatillo y colóquelo solamente cuando vaya a disparar.
- Utilice únicamente proyectiles específicos para esta arma.
- Mantenga la boca del arma siempre en una dirección segura.
- Sólo está permitido disparar el arma en la vivienda del propietario o en las zonas de tiro autorizadas por la policía, siempre y cuando el proyectil no pueda llegar más allá del área de tiro. Para ello, tenga presente siempre la distancia máxima de peligro del proyectil.
- Nunca transporte el arma cargada. Carguela solamente cuando tenga intención de disparar.
- Nunca apunte con el arma hacia personas o animales. Evite los disparos en los que el proyectil pueda rebotar: nunca dispare sobre superficies lisas y duras, ni al agua.
- Antes de disparar, asegúrese de que el objetivo y el entorno sean seguros.
- Antes de transportar el arma o de recibirla de manos de otra persona compruebe siempre que está descargada.
- Asegúrese de poder controlar la dirección hacia la que apunta la boca, aún en caso de tropiezo o de caída del arma.
- Por motivos de seguridad, cuando vaya a disparar póngase siempre gafas protectoras.
- Guarde el arma siempre descargada, separada de la munición y en lugar seguro para evitar que personas no aptas (personas sin formación, niños) puedan acceder a ella.
- Entregue esta arma, junto con las instrucciones de uso, únicamente a aquellas personas que:
 - estén perfectamente familiarizadas con el manejo de esta arma
 - hayan cumplido la edad mínima correspondiente fijada por la legislación en materia de armas del país respectivo.
- Cualquier modificación o reparación del arma deberá llevarla a cabo una empresa especializada o un armero.
- Nunca deje sin vigilancia un arma cargada.
- Siempre que entregue un arma a otra persona, asegúrese de que está descargada.

REPARACIONES

Una arma que no funcione perfectamente es peligrosa. Es difícil reparar uno mismo un arma, y un ensamblaje incorrecto puede producir anomalías de funcionamiento peligrosas.

Atención: La comprobación y reparación del arma sólo pueden llevarla a cabo especialistas autorizados o un armero.



INSTRUCCIONES DE SEGURIDAD | GARANTIA



DESIGNACION

ES



ATENCIÓN

Por su propia seguridad y la de los demás, lea detenidamente las instrucciones de uso antes de disparar el arma por primera vez. Vendedores y compradores están obligados a cumplir con las normas de uso y posesión de armas de aire comprimido. Queda prohibida cualquier modificación de esta arma, ya que ello podría implicar un cambio en su clasificación legal. En caso de modificación quedaría extinguida de inmediato la garantía del fabricante.



AVISO

No porte o muestre este arma de aire comprimido en público. Puede ser motivo de confusiones e ilegal. Miembros de las fuerzas de seguridad y la policía pueden tomarla por un arma de fuego real. No modifique el color ni los elementos identificativos para hacer que se parezca más a un arma de fuego real. Es peligroso y puede ser un delito

GARANTIA

La empresa Umarex se responsabiliza de reparar o sustituir su producto sin coste alguno en el plazo legalmente fijado a partir de la fecha de compra, siempre que el defecto no sea responsabilidad del propio usuario. Entregue el arma a un comerciante autorizado, describale el problema y adjunte el correspondiente comprobante de compra. Las armas de aire comprimido de la empresa UMAREX GmbH & Co. KG se fabrican de conformidad con las normas de homologación del Instituto Federal PTB (Physikalisch-Technischer Bundesanstalt), con la Ley Federal alemana, la normativa que establece el centro CIP y la experiencia en fabricación de armas de Umarex GmbH & Co. KG. Por eso, no asumimos ninguna responsabilidad en el caso de que al exportar el arma a un país extranjero, ésta no cumpliera con la normativa legal local y el propietario o comprador tuviera que responder jurídicamente por dicho incumplimiento.

ESPECIFICACIONES

Número de artículo	2.6382	2.6382X	2.6386	2.6386X	2.6387	2.6387X
	G36 C		G36 KV		G36 K	
Sistema	Gas Airsoft					
Calibre/Munición	cal. 6 mm BB					
Energía	max. 1,3 JOULES	max. 1 JOULE	max. 1,6 JOULES	max. 1 JOULE	max. 1,6 JOULES	max. 1 JOULE
Velocidad de disparo	hasta 114 m/s con 0,20 g BB	hasta 100 m/s con 0,20 g BB	hasta 125 m/s con 0,20 g BB	hasta 100 m/s con 0,20 g BB	hasta 125 m/s con 0,20 g BB	hasta 100 m/s con 0,20 g BB
Función	Semi-Auto	disparo completamente automático	Semi-Auto	disparo completamente automático	Semi-Auto	disparo completamente automático
Cadencia	-	800 tiro/min	-	800 tiro/min	-	800 tiro/min
Color	Negro					
Longitud del cañón	230 mm		390mm			
Peso	2520 g		2810 g		2875 g	
Longitud	720 mm		865 mm		865 mm	
Capacidad del cargador	30 BBs					
Distancia máxima de peligro	200 m					





⚠️ ATENCIÓN

- Manipule el arma sólo cuando con el seguro activado.
- Procure que la boca apunte siempre en una dirección segura.

⚠️ ATENCIÓN

Rogamos observe en todo caso la legislación vigente en su país sobre el uso de armas.

S-E-F grupo del disparador

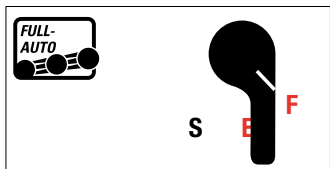
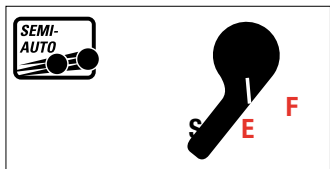
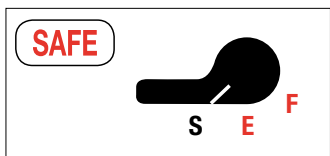

Pictogram grupo del disparador

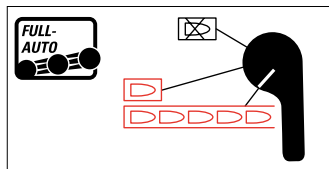
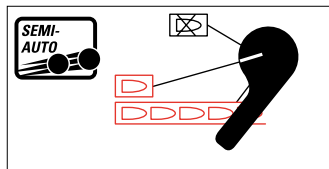
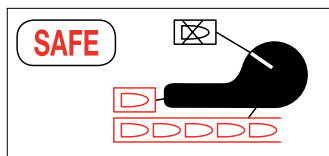

S-E-F grupo del disparador

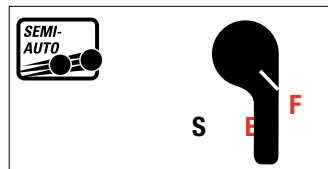
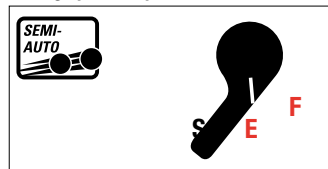

Pictogram grupo del disparador

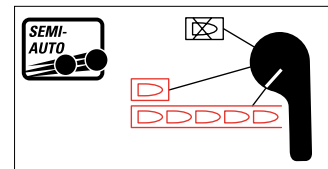
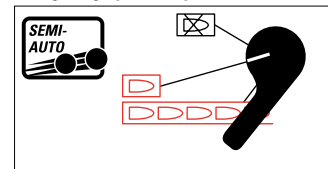

PROBLEMAS



PROBLEMAS

- Potencia de disparo deficiente
- El arma no dispara
- Escasa velocidad de disparo

POSIBLES CAUSAS

	Seguro activado	La batería / Cargador vacío	Cartón sucio	Temperaturas extremas	Munición errónea	Munición mal cargada	La mira no está bien ajustada
Potencia de disparo deficiente			●	●	●	●	●
El arma no dispara	●	●			●	●	
Escasa velocidad de disparo			●	●	●	●	



CARGA DEL GAS

⚠ ATENCIÓN

- Mantenga la cara y las manos a una distancia prudente de el gas.
- Las posibles fugas de pueden causar congelación.
- El gas pueden explotar a partir de los 50 °C.
- No fume y manténgase alejado de cualquier fuego. El gas es altamente inflamable.



Presione el retén del cargador. Extraiga el cargador de la pistola por la parte inferior de la empuñadura.

NOTA

Mantenga el cargador en gas el tanque inclinado hacia abajo. Introduzca la boquilla de la bombona de gas en la abertura del cargador en posición vertical. Apriete la bombona de gas en la abertura de carga. Cuando el gas se escape por los laterales de la abertura de carga significará que el cargador está lleno.

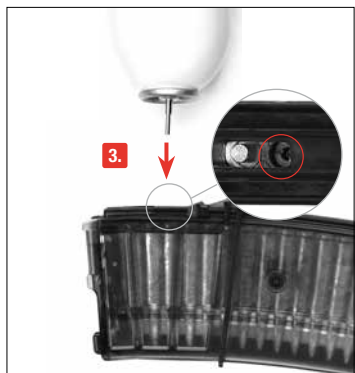

EXTIRPAR DEL GAS

Sujete el cargador hacia abajo. Presione la válvula y desplace el seguro de la válvula hacia arriba. El gas restante se saldrá del cargador.



CARGA DEL CARGADOR

ES

⚠ NOTA

No necesita volver a amartillar, si tiene que recargar BBs mientras dispara.



1. Arme la palanca de armado. Presione retén del cerrojo



Presione

3. Extraiga el cargador



Cargar los BBs

Abra



Click

7. Presione

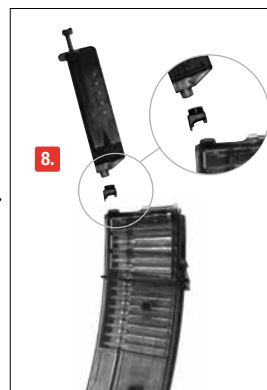

8.



9. Presionar repetidamente el botón hasta que se hayan cargado hasta 30 BBs.

Cargar los BBs



AJUSTE DE SHOOT UP

ES

⚠ ATENCIÓN



Utilice únicamente bolas BB (que no presenten defectos) de calibre 6 mm.

No utilice en ningún caso los siguientes tipos de bolas BB:

1 Diámetro superior a los 6 mm, 2 Con cortes, 3 Con mitades que no coinciden, 4 Usadas o sucias. Si se utilizan proyectiles distintos de los apropiados, quedará anulada la garantía. Se recomienda el uso de bolas de precisión de la marca Umarex/Walther. Para garantizar el buen funcionamiento del magazín, evite que la suciedad o el polvo entren en el mismo.



Tire hacia atrás de la palanca de armado, suéltela a continuación. La corredera se mueve hacia delante. El arma está ahora lista para disparar.

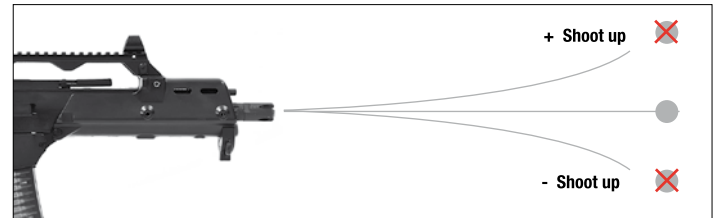



AJUSTE DE MIRA / DISTANCIA



TELESCOPIO

ES

Ajuste en deriva

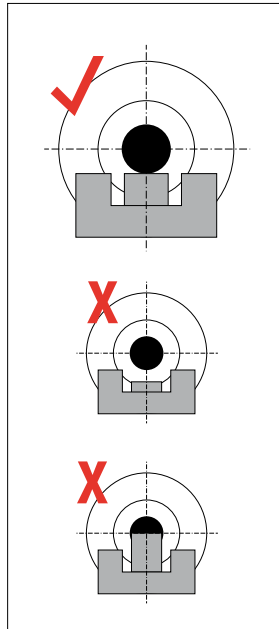
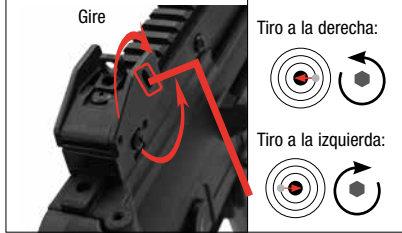

Ajuste en altura

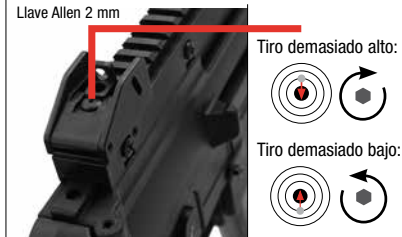

Telescopio 3,5 x ampliación

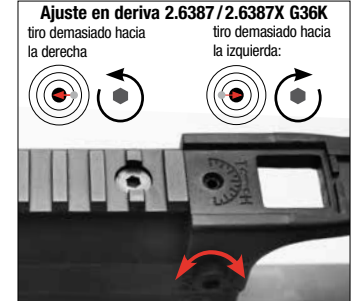



CULATA / DISPARO

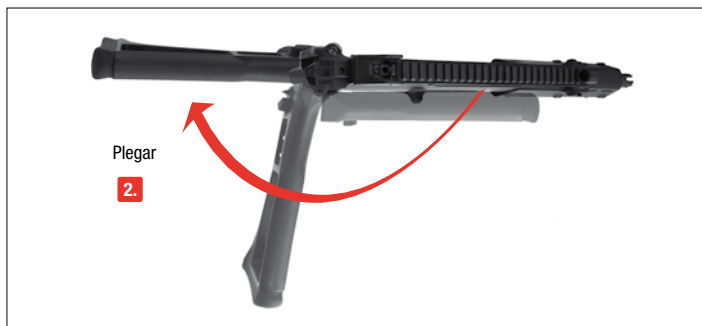
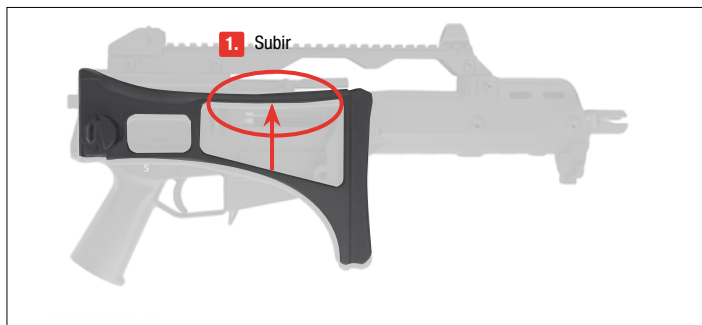

LA LIMPIEZA DE CAÑÓN

ES

⚠️ ATENCIÓN

Durante implicar el gatillo nunca conmute el conmutador. Esto causa daños graves.



⚠️ ATENCIÓN

- No debe forzar la varilla de limpieza para introducirla dentro del cañón, porque podría dañar el arma.
- Limpie las piezas metálicas exteriores con un trapo suave, humedecido con aceite para armas.
- No vierta nunca aceite de silicona directamente dentro del cañón.

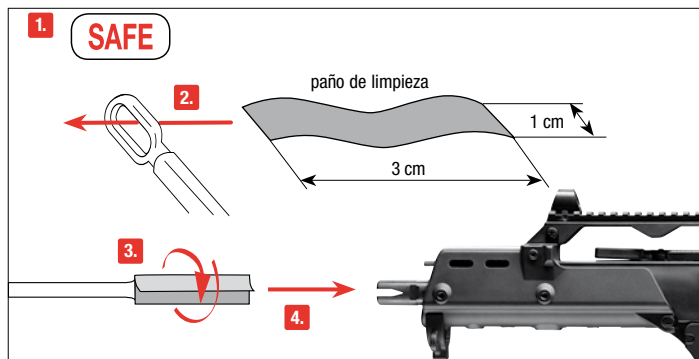

Asegure el arma. Coja una barra estrecha y larga de unos 30 cm. Enrolle un paño de algodón por el extremo, humedézcalo con un poco de aceite para armas y limpie el cañón con ayuda del mismo.

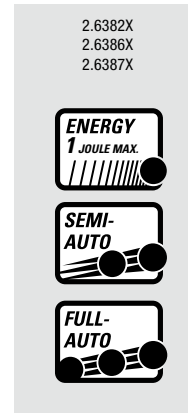
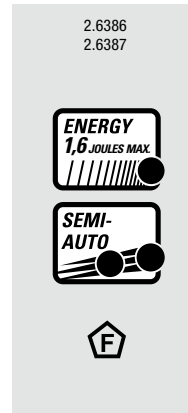
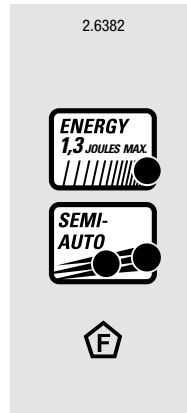
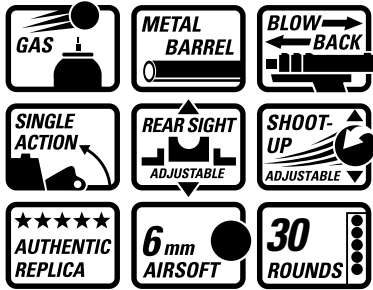

UMAREX

UMAREX GmbH & Co. KG

Donnerfeld 2
59757 Arnsberg | Germany
Phone: +49 29 32 / 638-01
Fax: +49 29 32 / 638-222
verkauf@umarex.de | sales@umarex.de

www.umarex.com

We reserve the right to make color and design changes and technical improvements. No responsibility is accepted for printing errors or incorrect information.

Änderungen in Farbe und Design, sowie technische Verbesserungen, Druckfehler und Irrtum vorbehalten. Alle Angaben ohne Gewähr.

Sauf modifications de la couleur et du design ainsi que des améliorations techniques, erreurs d'impression et erreur. Toutes les données sont fournies sans garantie.

Salvo modificaciones de color y de diseño así como mejoramientos técnicos, erratas y error. Todos los datos sin garantía.

© Umarex GmbH & Co. KG